

FAQSERIES













INTERCHANGE > Stucchi profile (only for Stucchi multicouplings)



Stucchi®



TECHNICAL FEATURES AND OPTIONS

 Interchange Stucchi profile (only for Stucchi multicouplings)	 Sealing description Nitrile NBR	 Connection system By multicoupling
 Available sizes from 3/8" to 3/4"	 Material/treatment Carbon steel-Stainless steel/QPQ	 Available threads BSP - NPT
 Operating pressure Up to 20 bar	 Locking mechanism PIN/CAM	 Flow rate Up to 200 l/min
 Temperature (°C) oil -20°/+100° water +5°/+60°	 Valving style Flat face	 Connection under pressure Connection: not allowed. Disconnection: not allowed.

BENEFITS

- Designed to be used with fluids like air, water or water & glycol lines.
- Flat face is easy to clean, helping to reduce the inclusion of contamination to the hydraulic circuit.
- Minimal fluid loss during connection/disconnection, reducing fluid loss to the environment.
- Minimal air inclusion during connection/disconnection, enhancing correct function of the circuit.
- Linear flow reduces internal turbulence and pressure drop, maintaining circuit efficiency in the entire system.
- Superior corrosion resistance compared to zinc plating in specific corrosive environments (example: water, water&glycol, cooling fluids).
- The modular design allows flexibility with the range of port configurations.
- Allows to conduct in the same multiconnection different fluids.
- Double oring in the male valving to improve sealing action when connected.
- For diagnostic purpose of a single line (example: pressure or flow check for a short&limited time), male FAQ may be connected with a Stucchi FIRG-Q series flat face female.
- Couplings are assembled with a seeger ring for a quicker mounting or service on the multiconnection.

HOW TO USE

- See instructions at page 24

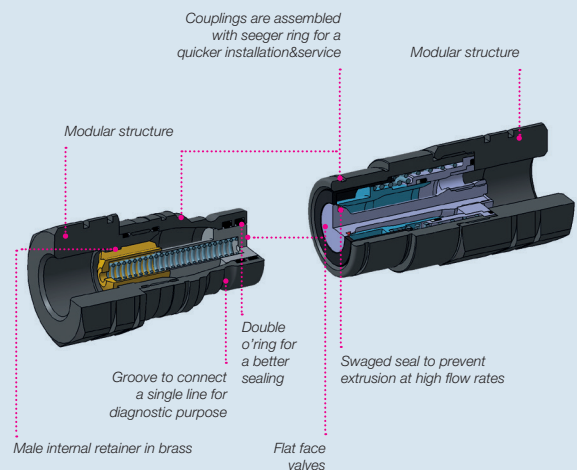
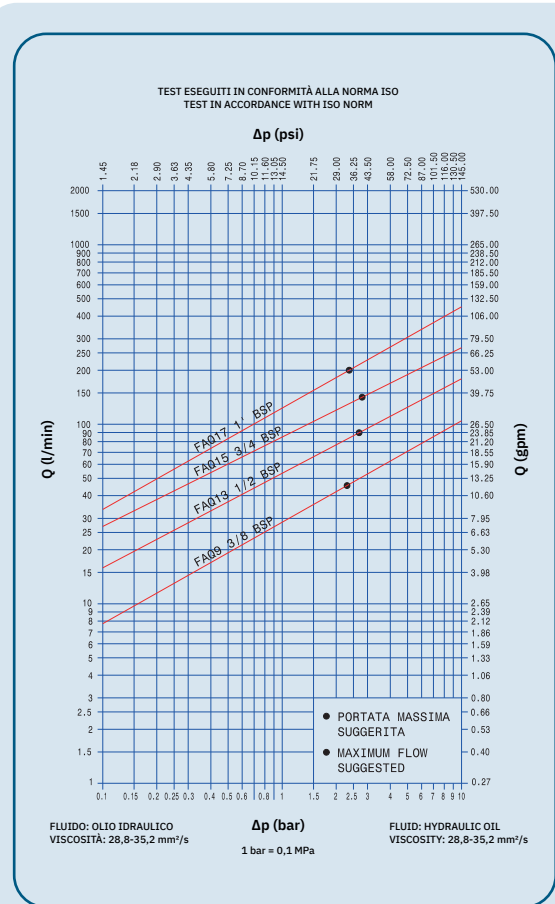

MAIN APPLICATIONS



PERFORMANCE

Size		Series/Size	Max. flow suggested		Hydrostatic pushing area coupled	Spillage*
Inch	mm (ISO)		l/min	GPM	Cm ²	ml
3/8	-	FAQ9	46	12,19	1,226	0,012
1/2	-	FAQ13	90	23,85	1,893	0,020
5/8	-	FAQ15	148	39,22	2,404	0,026
3/4	-	FAQ17	200	53,00	3,298	0,032

Size	Series/Size	Max. operating pressure					
		Coupled		Male		Female	
Inch		MPa	psi	MPa	psi	MPa	psi
3/8	FAQ9	2	290	2	290	2	290
1/2	FAQ13	2	290	2	290	2	290
5/8	FAQ15	2	290	2	290	2	290
3/4	FAQ17	2	290	2	290	2	290

* Spillage is an indicative value of the fluid loss per couple-uncouple cycle without residual pressure.

Different possible configurations:

Different threads available upon request.

Temperature range:

Seals in NBR (Nitrile):

- for oil, from -20° C to +100° C (from -4° F to +212° F).
- for water, from +5° C + 60° C (from +41° F to +140° F).

Upon request seals in VITON®: from -15°C to +180°C (from +5 °F to +356 °F).

Upon request EPDM (Ethylene Propylene) seals: from -40°C to +150°C (from -40 °F to +302 °F). Please read carefully "instruction and warning" for proper selection of the products.

! WARNING

A defect, a wrong choice or an improper use of products, can cause injury to persons, animals and objects.

Never connect or disconnect with dynamic pressure (e.g. pump on).
Do not use the female coupling disconnected with high impulse pressure.

Do not couple-uncouple with flow and/or pressure in the circuit.

Do not couple-uncouple when the temperature inside of the circuit is higher than 80 °C (176 °F).

Check the maximum allowable operating pressure of the port in use.

Make sure that the medium used is compatible with seal and material as indicated for each series.

In case of doubt please contact Stucchi Technical Support.

It is MANDATORY to read and closely follow the instructions. Last updated version always apply at time of installation, see latest written Instructions on Stucchi website (stucchigroup.com) before selecting or using Stucchi products.

Connection and disconnection has to be done without pressure only

When the multicoupling is disconnected, it is suggested to use the protection caps&parking station.

Do not disassemble, misuse, modify or damage the products.

FAQ series is intended to be used only on Stucchi Multiconnections. Do not use the FAQ coupling on a Custom-made multiconnection or other device different than a Stucchi Multiconnection.

FAQ series has been tested&approved for use with water. FAQ series is intended to be used only with not dangerous fluids (water, water&glycol, hydraulic oil) . Do not use

FAQ couplings with dangerous, flammable or explosive fluids (steam, acids, very hot/flammable oils, gases, dangerous gases etc.). Contact Stucchi Service for support.

Do not use FAQ couplings with very hot fluids (limits given by NBR seal compatibility&temperature range – see "performance" of FAQ serie).

Do not use FAQ couplings with fluids below the freezing point to avoid damages due to ice expansion and consequential extrusion of the valving

For dimension "FAQ9 - size 3/8": there are two versions of FAQ9: "A" and "D". The version is depending the type of multiconnection are in use. Please verify if the

multiconnection you are using requires FAQ9 "A" or "D" type consulting the single datasheet in case of need of spare parts. See specific instruction.

Contact Stucchi Service for support.

SPECIFICATIONS

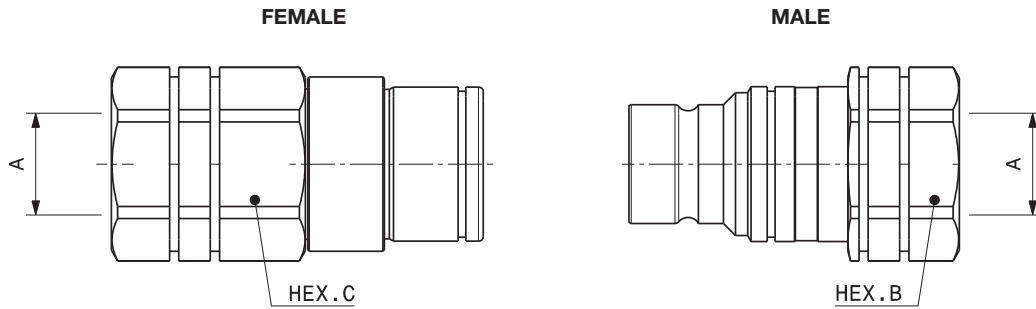

Port description: FEMALE THREAD BSPP (ISO 1179-1)

Body size	Descriptive Code	Item Code	Port (A)	A or D type	Hex	Hex		Weight	
						mm	inch	Kg	Lbs
3/8"	F FAQ9A 3/8 BSP	Female 806900018	3/8"	A	C	30,0	1,18	0,24	0,54
	M FAQ9A 3/8 BSP	Male 806900019			B	27,0	1,06	0,16	0,35
3/8"	F FAQ9D 3/8 BSP	Female 806900022	3/8"	D	C	30,0	1,18	0,24	0,54
	M FAQ9D 3/8 BSP	Male 806900023			B	27,0	1,06	0,18	0,39
1/2"	F FAQ13 1/2 BSP	Female 806900006	1/2"	-	C	36,0	1,42	0,42	0,93
	M FAQ13 1/2 BSP	Male 806900007			B	36,0	1,42	0,28	0,63
5/8"	F FAQ15 3/4 BSP	Female 806900010	3/4"	-	C	41,0	1,61	0,58	1,29
	M FAQ15 3/4 BSP	Male 806900011			B	36,0	1,42	0,30	0,65

Port description: FEMALE THREAD NPT (ANSI B1.20.1)

Body size	Descriptive Code	Item Code	Port (A)	A or D type	Hex	Hex		Weight	
						mm	inch	Kg	Lbs
3/8"	F FAQ9D 3/8 NPT	Female 806901022	3/8"	D	C	30,0	1,18	0,24	0,53
	M FAQ9D 3/8 NPT	Male 806901023			B	27,0	1,06	0,18	0,39
5/8"	F FAQ15 3/4 NPT	Female 806901010	3/4"	-	C	44,8	1,77	0,59	1,30
	M FAQ15 3/4 NPT	Male 806901011			B	38,5	1,52	0,52	1,15

Size 3/4 (FAQ17) available upon request.



SPARE KIT SEAL FOR MALE

Repair kit / OR+BK		
Body Size	Description	Part Number
3/8"	SET OF 10 OR NBR M FAQ9	815701065
1/2"	SET OF 10 OR NBR M FAQ13	815701067
5/8"	SET OF 10 OR NBR M FAQ15	815701069

O-Ring in Nitrile
(kit composed of 10 O-Ring for male coupling; 1 male = 2 O-Ring)

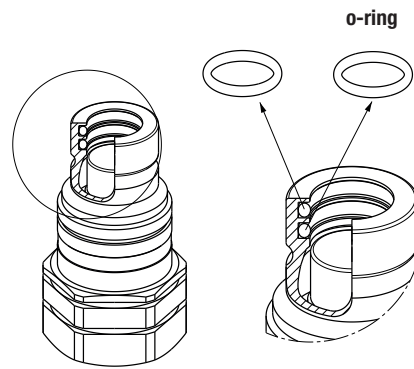

REPAIR KIT/SEEGER

Repair kit/Seeger	
Part Number	Description
815701033	SET OF 10 SEEGER FOR PLUG FAP-FAQ9
815701034	SET OF 10 SEEGER FOR PLUG FAP-FAQ13
815701035	SET OF 5 SEEGER FOR PLUG FAP-FAQ15
815701036	SET OF 5 SEEGER FOR PLUG FAP-FAQ17

